

23P17/8

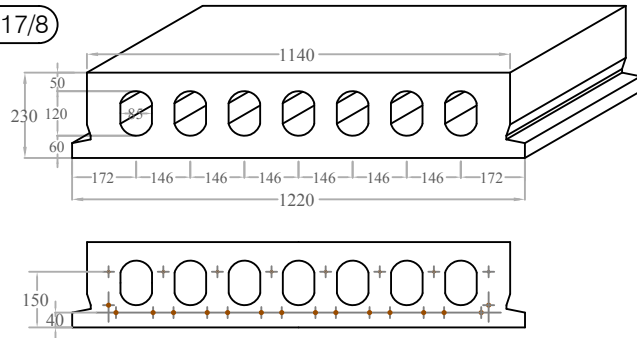

PRODUCTION DIMENSIONS

width - 1220mm
height - 230mm

Date Issued:
September 2005

OWN WEIGHT

Own weight per linear metre 477.84 kg/ l.m

Thickness of Panel - mm	Area mm ²	Centroid mm	Moments of Inertia mm ⁴	Radii of Gyration mm
230	203889	X - 610 Y - 112	I - 1.12x10 ⁹ J - 2.42x10 ¹⁰	X - 74.24 Y - 344.57

PRECAST PRESTRESSED CONCRETE PANELS - SAFE LOAD TABLES

SPAN	SAFE LOAD	MAX. SAFE SHEAR
2.50m (8.20ft)	6797.88kg/m ² (1392.20lbs/ft ²)	10.20Ton. per Panel
2.75m (9.02ft)	6143.69kg/m ² (1258.23lbs/ft ²)	10.14Ton. per Panel
3.00m (9.84ft)	5598.53kg/m ² (1146.58lbs/ft ²)	10.08Ton. per Panel
3.25m (10.66ft)	5137.24kg/m ² (1052.11lbs/ft ²)	10.02Ton. per Panel
3.50m (11.48ft)	4741.85kg/m ² (971.13lbs/ft ²)	9.96Ton. per Panel
3.75m (12.30ft)	4399.18kg/m ² (900.95lbs/ft ²)	9.90Ton. per Panel
4.00m (13.12ft)	4099.35kg/m ² (839.55lbs/ft ²)	9.84Ton. per Panel
4.25m (13.94ft)	3823.69kg/m ² (783.09lbs/ft ²)	9.78Ton. per Panel
4.50m (14.76ft)	3367.62kg/m ² (689.69lbs/ft ²)	9.72Ton. per Panel
4.75m (15.58ft)	2981.65kg/m ² (610.64lbs/ft ²)	9.66Ton. per Panel
5.00m (16.40ft)	2652.11kg/m ² (543.15lbs/ft ²)	9.60Ton. per Panel
5.25m (17.23ft)	2368.52kg/m ² (485.07lbs/ft ²)	9.54Ton. per Panel
5.50m (18.05ft)	2122.72kg/m ² (434.73lbs/ft ²)	9.48Ton. per Panel
5.75m (18.87ft)	1908.27kg/m ² (390.81lbs/ft ²)	9.42Ton. per Panel
6.00m (19.69ft)	1720.07kg/m ² (352.27lbs/ft ²)	9.36Ton. per Panel
6.25m (20.51ft)	1554.00kg/m ² (318.26lbs/ft ²)	9.30Ton. per Panel
6.50m (21.33ft)	1406.72kg/m ² (288.10lbs/ft ²)	9.24Ton. per Panel
6.75m (22.15ft)	1275.50kg/m ² (261.22lbs/ft ²)	9.18Ton. per Panel
7.00m (22.97ft)	1158.08kg/m ² (237.17lbs/ft ²)	9.12Ton. per Panel
7.25m (23.79ft)	1052.60kg/m ² (215.57lbs/ft ²)	9.06Ton. per Panel
7.50m (24.61ft)	957.49kg/m ² (196.09lbs/ft ²)	9.00Ton. per Panel
7.75m (25.43ft)	871.44kg/m ² (178.47lbs/ft ²)	8.94Ton. per Panel

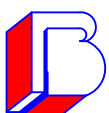

BALLUT BLOCKS SERVICES LTD.

WIED FILEP L/o NAXXAR - MALTA.

Tel: 21572666, 21573093, 21487738
Fax: 21575562
Email: ballut@maltanet.net

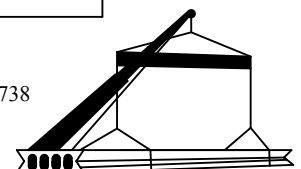

23P17/8

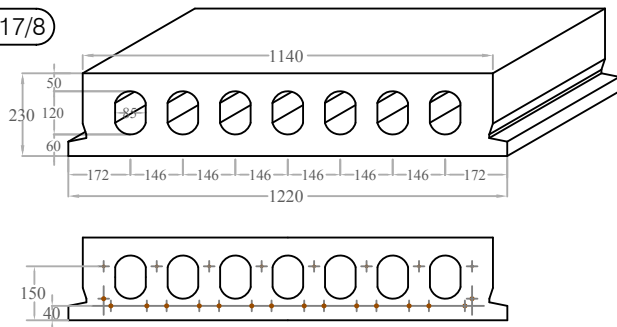

PRODUCTION DIMENSIONS

width - 1220mm
height - 230mm

Date Issued:
September 2005

OWN WEIGHT

Own weight per linear metre 477.84 kg/ l.m

Thickness of Panel - mm	Area mm ²	Centroid mm	Moments of Inertia mm ⁴	Radii of Gyration mm
230	203889	X - 610 Y - 112	I - 1.12x10 ⁹ J - 2.42x10 ¹⁰	X - 74.24 Y - 344.57

PRECAST PRESTRESSED CONCRETE PANELS - SAFE LOAD TABLES

SPAN	SAFE LOAD	MAX. SAFE SHEAR
8.00m (26.25ft)	793.33kg/m ² (162.47lbs/ft ²)	8.88Ton. per Panel
8.25m (27.07ft)	722.21kg/m ² (147.91lbs/ft ²)	8.82Ton. per Panel
8.50m (27.89ft)	657.27kg/m ² (134.61lbs/ft ²)	8.76Ton. per Panel
8.75m (28.71ft)	597.82kg/m ² (122.43lbs/ft ²)	8.70Ton. per Panel
9.00m (29.53ft)	543.25kg/m ² (111.26lbs/ft ²)	8.64Ton. per Panel
9.25m (30.35ft)	493.05kg/m ² (100.98lbs/ft ²)	8.58Ton. per Panel
9.50m (31.17ft)	446.76kg/m ² (91.50lbs/ft ²)	8.52Ton. per Panel
9.75m (31.99ft)	403.98kg/m ² (82.74lbs/ft ²)	8.46Ton. per Panel
10.00m (32.81ft)	364.38kg/m ² (74.62lbs/ft ²)	8.40Ton. per Panel
10.25m (33.63ft)	327.63kg/m ² (67.10lbs/ft ²)	8.35Ton. per Panel
10.50m (34.45ft)	293.48kg/m ² (60.10lbs/ft ²)	8.29Ton. per Panel
10.75m (35.27ft)	261.68kg/m ² (53.59lbs/ft ²)	8.23Ton. per Panel
11.00m (36.09ft)	232.03kg/m ² (47.52lbs/ft ²)	8.17Ton. per Panel
11.25m (36.91ft)	204.33kg/m ² (41.85lbs/ft ²)	8.11Ton. per Panel



BALLUT BLOCKS SERVICES LTD.

WIED FILEP L/o NAXXAR - MALTA.

Tel: 21572666, 21573093, 21487738
Fax: 21575562
Email: ballut@maltanet.net

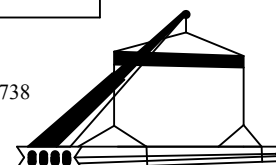

28P22/8

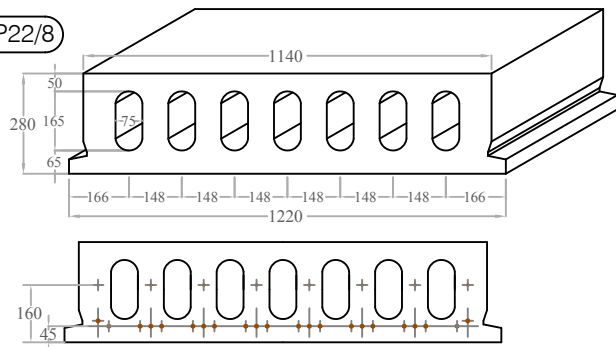

PRODUCTION DIMENSIONS

width - 1220mm
height - 280 mm

Date Issued:
September 2005

OWN WEIGHT

Own weight per linear metre 537.52 kg/l.m

Thickness of Panel - mm	Area mm ²	Centroid mm	Moments of Inertia mm ⁴	Radii of Gyration mm
280	243872	X - 610 Y - 136	I - 1.97x10 ⁹ J - 2.88x10 ¹⁰	X - 89.96 Y - 343.51

PRECAST PRESTRESSED CONCRETE PANELS - SAFE LOAD TABLES

SPAN	SAFE LOAD	MAX. SAFE SHEAR
2.50m (8.20ft)	8308.06kg/m ² (1701.49lbs/ft ²)	12.46Ton. per Panel
2.75m (9.02ft)	7512.06kg/m ² (1538.47lbs/ft ²)	12.39Ton. per Panel
3.00m (9.84ft)	6848.73kg/m ² (1402.62lbs/ft ²)	12.33Ton. per Panel
3.25m (10.66ft)	6327.00kg/m ² (1287.67lbs/ft ²)	12.26Ton. per Panel
3.50m (11.48ft)	5806.35kg/m ² (1189.14lbs/ft ²)	12.19Ton. per Panel
3.75m (12.30ft)	5389.39kg/m ² (1103.75lbs/ft ²)	12.13Ton. per Panel
4.00m (13.12ft)	5024.56kg/m ² (1029.03lbs/ft ²)	12.06Ton. per Panel
4.25m (13.94ft)	4702.65kg/m ² (963.10lbs/ft ²)	11.99Ton. per Panel
4.50m (14.76ft)	4416.50kg/m ² (904.50lbs/ft ²)	11.92Ton. per Panel
4.75m (15.58ft)	4160.48kg/m ² (852.07lbs/ft ²)	11.86Ton. per Panel
5.00m (16.40ft)	3930.06kg/m ² (804.88lbs/ft ²)	11.79Ton. per Panel
5.25m (17.23ft)	3721.58kg/m ² (762.18lbs/ft ²)	11.72Ton. per Panel
5.50m (18.05ft)	3532.06kg/m ² (723.37lbs/ft ²)	11.66Ton. per Panel
5.75m (18.87ft)	3359.02kg/m ² (687.93lbs/ft ²)	11.59Ton. per Panel
6.00m (19.69ft)	3200.39kg/m ² (655.44lbs/ft ²)	11.52Ton. per Panel
6.25m (20.51ft)	2972.84kg/m ² (608.84lbs/ft ²)	11.45Ton. per Panel
6.50m (21.33ft)	2714.76kg/m ² (555.98lbs/ft ²)	11.39Ton. per Panel
6.75m (22.15ft)	2484.82kg/m ² (508.89lbs/ft ²)	11.32Ton. per Panel
7.00m (22.97ft)	2279.08kg/m ² (466.76lbs/ft ²)	11.25Ton. per Panel
7.25m (23.79ft)	2094.25kg/m ² (428.90lbs/ft ²)	11.19Ton. per Panel
7.50m (24.61ft)	1927.60kg/m ² (394.77lbs/ft ²)	11.12Ton. per Panel
7.75m (25.43ft)	1776.81kg/m ² (363.89lbs/ft ²)	11.05Ton. per Panel
8.00m (26.25ft)	1639.94kg/m ² (335.86lbs/ft ²)	10.98Ton. per Panel
8.25m (27.07ft)	1515.32kg/m ² (310.34lbs/ft ²)	10.92Ton. per Panel



BALLUT BLOCKS SERVICES LTD.

Tel: 21572666, 21573093, 21487738
Fax: 21575562
Email: ballut@maltanet.net

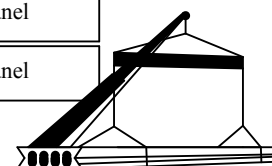

28P22/8

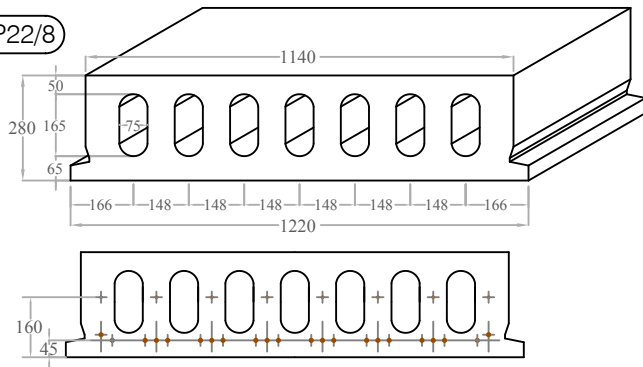

PRODUCTION DIMENSIONS

width - 1220mm
height - 280mm

Date Issued:
September 2005

OWN WEIGHT

Own weight per linear metre 537.52 kg/ l.m

Thickness of Panel - mm	Area mm ²	Centroid mm	Moments of Inertia mm ⁴	Radii of Gyration mm
280	243872	X - 610 Y - 136	I - 1.97x10 ⁹ J - 2.88x10 ¹⁰	X - 89.96 Y - 343.51

PRECAST PRESTRESSED CONCRETE PANELS - SAFE LOAD TABLES

SPAN	SAFE LOAD	MAX. SAFE SHEAR
8.50m (27.89ft)	1401.53kg/m ² (287.03lbs/ft ²)	10.85Ton. per Panel
8.75m (28.71ft)	1297.35kg/m ² (265.70lbs/ft ²)	10.78Ton. per Panel
9.00m (29.53ft)	1201.74kg/m ² (246.12lbs/ft ²)	10.72Ton. per Panel
9.25m (30.35ft)	1113.77kg/m ² (228.10lbs/ft ²)	10.65Ton. per Panel
9.50m (31.17ft)	1032.66kg/m ² (211.49lbs/ft ²)	10.58Ton. per Panel
9.75m (31.99ft)	957.71kg/m ² (196.14lbs/ft ²)	10.51Ton. per Panel
10.00m (32.81ft)	888.30kg/m ² (181.92lbs/ft ²)	10.45Ton. per Panel
10.25m (33.63ft)	823.91kg/m ² (168.74lbs/ft ²)	10.38Ton. per Panel
10.50m (34.45ft)	764.07kg/m ² (156.48lbs/ft ²)	10.31Ton. per Panel
10.75m (35.27ft)	708.35kg/m ² (145.07lbs/ft ²)	10.24Ton. per Panel
11.00m (36.09ft)	656.39kg/m ² (134.43lbs/ft ²)	10.18Ton. per Panel
11.25m (36.91ft)	607.86kg/m ² (124.49lbs/ft ²)	10.11Ton. per Panel
11.50m (37.73ft)	562.45kg/m ² (115.19lbs/ft ²)	10.04Ton. per Panel
11.75m (38.55ft)	519.91kg/m ² (106.48lbs/ft ²)	9.98Ton. per Panel
12.00m (39.37ft)	480.01kg/m ² (98.31lbs/ft ²)	9.91Ton. per Panel
12.25m (40.19ft)	442.52kg/m ² (90.63lbs/ft ²)	9.84Ton. per Panel
12.50m (41.01ft)	407.26kg/m ² (83.41lbs/ft ²)	9.77Ton. per Panel
12.75m (41.83ft)	374.05kg/m ² (76.60lbs/ft ²)	9.71Ton. per Panel
13.00m (42.65ft)	342.74kg/m ² (70.19lbs/ft ²)	9.64Ton. per Panel
13.25m (43.47ft)	313.18kg/m ² (64.14lbs/ft ²)	9.57Ton. per Panel
13.50m (44.29ft)	285.25kg/m ² (58.42lbs/ft ²)	9.51Ton. per Panel
13.75m (45.11ft)	258.83kg/m ² (53.01lbs/ft ²)	9.44Ton. per Panel
14.00m (45.93ft)	233.82kg/m ² (47.89lbs/ft ²)	9.37Ton. per Panel
14.25m (46.75ft)	210.11kg/m ² (43.03lbs/ft ²)	9.30Ton. per Panel



BALLUT BLOCKS SERVICES LTD.

Tel: 21572666, 21573093, 21487738
Fax: 21575562
Email: ballut@maltanet.net

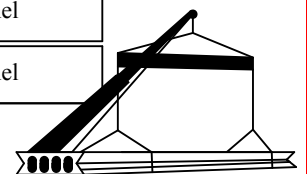

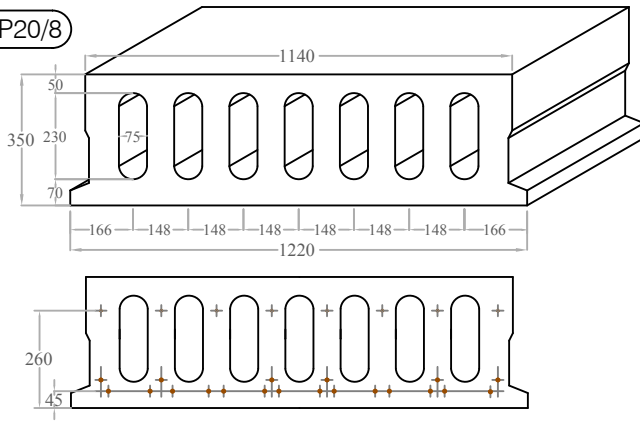
35P20/8**PRODUCTION DIMENSIONS**

width - 1220mm
height - 350mm

Date Issued:
September 2005

OWN WEIGHT

Own weight per linear metre 696.36 kg/ l.m

Thickness of Panel - mm	Area mm ²	Centroid mm	Moments of Inertia mm ⁴	Radii of Gyration mm
350	287848	X - 610 Y - 170	I - 3.70x10 ⁹ J - 3.39x10 ¹⁰	X - 113.29 Y - 343.05

PRECAST PRESTRESSED CONCRETE PANELS - SAFE LOAD TABLES

SPAN	SAFE LOAD	MAX. SAFE SHEAR
2.50m (8.20ft)	11085.95kg/m ² (2270.40lbs/ft ²)	16.63Ton. per Panel
2.75m (9.02ft)	10025.38kg/m ² (2053.20lbs/ft ²)	16.54Ton. per Panel
3.00m (9.84ft)	9141.58kg/m ² (1872.19lbs/ft ²)	16.45Ton. per Panel
3.25m (10.66ft)	8393.74kg/m ² (1719.04lbs/ft ²)	16.37Ton. per Panel
3.50m (11.48ft)	7752.74kg/m ² (1587.76lbs/ft ²)	16.28Ton. per Panel
3.75m (12.30ft)	7197.20kg/m ² (1473.99lbs/ft ²)	16.19Ton. per Panel
4.00m (13.12ft)	6711.11kg/m ² (1374.43lbs/ft ²)	16.11Ton. per Panel
4.25m (13.94ft)	6282.20kg/m ² (1286.59lbs/ft ²)	16.02Ton. per Panel
4.50m (14.76ft)	5900.95kg/m ² (1208.51lbs/ft ²)	15.93Ton. per Panel
4.75m (15.58ft)	5559.83kg/m ² (1138.65lbs/ft ²)	15.85Ton. per Panel
5.00m (16.40ft)	5252.82kg/m ² (1075.78lbs/ft ²)	15.76Ton. per Panel
5.25m (17.23ft)	4822.33kg/m ² (987.61lbs/ft ²)	15.67Ton. per Panel
5.50m (18.05ft)	4342.35kg/m ² (889.31lbs/ft ²)	15.58Ton. per Panel
5.75m (18.87ft)	3923.60kg/m ² (803.55lbs/ft ²)	15.50Ton. per Panel
6.00m (19.69ft)	3556.09kg/m ² (728.29lbs/ft ²)	15.41Ton. per Panel
6.25m (20.51ft)	3231.80kg/m ² (661.87lbs/ft ²)	15.32Ton. per Panel
6.50m (21.33ft)	2944.20kg/m ² (602.97lbs/ft ²)	15.24Ton. per Panel
6.75m (22.15ft)	2687.96kg/m ² (550.49lbs/ft ²)	15.15Ton. per Panel
7.00m (22.97ft)	2458.68kg/m ² (503.54lbs/ft ²)	15.06Ton. per Panel
7.25m (23.79ft)	2252.71kg/m ² (461.35lbs/ft ²)	14.98Ton. per Panel
7.50m (24.61ft)	2066.99kg/m ² (423.32lbs/ft ²)	14.89Ton. per Panel
7.75m (25.43ft)	1898.95kg/m ² (388.91lbs/ft ²)	14.80Ton. per Panel
8.00m (26.25ft)	1746.42kg/m ² (357.67lbs/ft ²)	14.71Ton. per Panel

**BALLUT BLOCKS SERVICES LTD.**

Tel: 21572666, 21573093, 21487738
Fax: 21575562
Email: ballut@maltanet.net

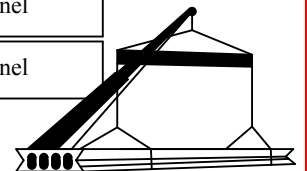

35P20/8

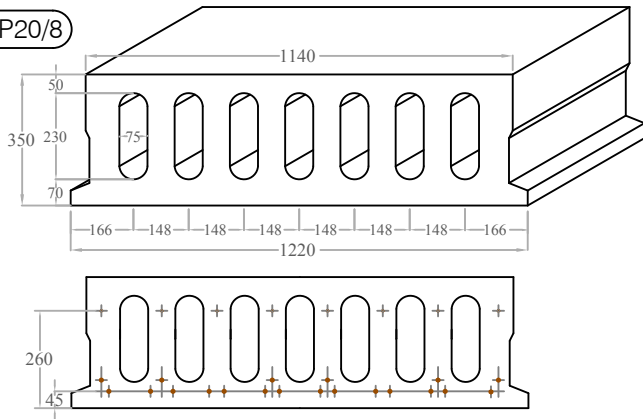

PRODUCTION DIMENSIONS

width - 1220mm
height - 350mm

Date Issued:
September 2005

OWN WEIGHT

Own weight per linear metre 696.36 kg/ l.m

Thickness of Panel - mm	Area mm ²	Centroid mm	Moments of Inertia mm ⁴	Radii of Gyration mm
350	287848	X - 610 Y - 170	I - 3.70x10 ⁹ J - 3.39x10 ¹⁰	X - 113.29 Y - 343.05

PRECAST PRESTRESSED CONCRETE PANELS - SAFE LOAD TABLES

SPAN	SAFE LOAD	MAX. SAFE SHEAR
8.25m (27.07ft)	1607.54kg/m ² (329.22lbs/ft ²)	14.63Ton. per Panel
8.50m (27.89ft)	1480.74kg/m ² (303.26lbs/ft ²)	14.54Ton. per Panel
8.75m (28.71ft)	1364.65kg/m ² (279.48lbs/ft ²)	14.45Ton. per Panel
9.00m (29.53ft)	1258.09kg/m ² (257.66lbs/ft ²)	14.37Ton. per Panel
9.25m (30.35ft)	1160.06kg/m ² (237.58lbs/ft ²)	14.28Ton. per Panel
9.50m (31.17ft)	1069.67kg/m ² (219.07lbs/ft ²)	14.19Ton. per Panel
9.75m (31.99ft)	986.14kg/m ² (201.96lbs/ft ²)	14.10Ton. per Panel
10.00m (32.81ft)	908.80kg/m ² (186.12lbs/ft ²)	14.02Ton. per Panel
10.25m (33.63ft)	837.05kg/m ² (171.43lbs/ft ²)	13.93Ton. per Panel
10.50m (34.45ft)	770.36kg/m ² (157.77lbs/ft ²)	13.84Ton. per Panel
10.75m (35.27ft)	708.27kg/m ² (145.05lbs/ft ²)	13.76Ton. per Panel
11.00m (36.09ft)	650.36kg/m ² (133.19lbs/ft ²)	13.67Ton. per Panel
11.25m (36.91ft)	596.27kg/m ² (122.12lbs/ft ²)	13.58Ton. per Panel
11.50m (37.73ft)	545.67kg/m ² (111.75lbs/ft ²)	13.50Ton. per Panel
11.75m (38.55ft)	498.27kg/m ² (102.05lbs/ft ²)	13.41Ton. per Panel
12.00m (39.37ft)	453.80kg/m ² (92.94lbs/ft ²)	13.32Ton. per Panel
12.25m (40.19ft)	412.02kg/m ² (84.38lbs/ft ²)	13.23Ton. per Panel
12.50m (41.01ft)	372.72kg/m ² (76.33lbs/ft ²)	13.15Ton. per Panel
12.75m (41.83ft)	335.71kg/m ² (68.75lbs/ft ²)	13.06Ton. per Panel
13.00m (42.65ft)	300.82kg/m ² (61.61lbs/ft ²)	12.97Ton. per Panel
13.25m (43.47ft)	267.89kg/m ² (54.86lbs/ft ²)	12.89Ton. per Panel
13.50m (44.29ft)	236.76kg/m ² (48.49lbs/ft ²)	12.80Ton. per Panel
13.75m (45.11ft)	207.32kg/m ² (42.46lbs/ft ²)	12.71Ton. per Panel

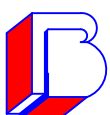

BALLUT BLOCKS SERVICES LTD.

Tel: 21572666, 21573093, 21487738
Fax: 21575562
Email: ballut@maltanet.net

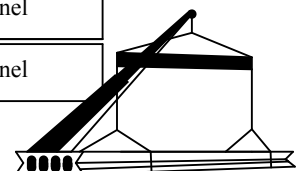

38P24/8

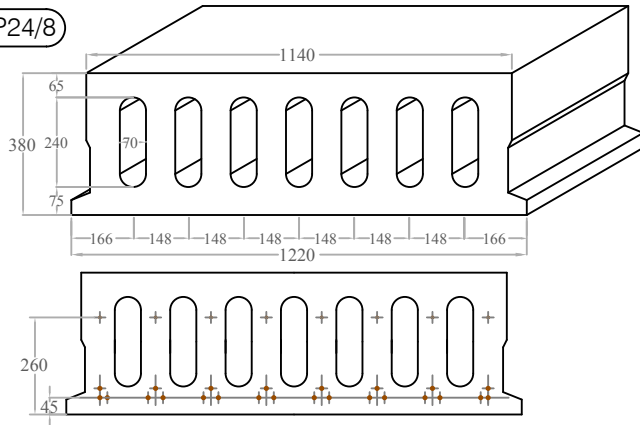

PRODUCTION DIMENSIONS

width - 1220mm
height - 380mm

Date Issued:
September 2005

OWN WEIGHT

Own weight per linear metre 753.36 kg/ l.m

Thickness of Panel - mm	Area mm ²	Centroid mm	Moments of Inertia mm ⁴	Radii of Gyration mm
380	324161	X - 610 Y - 187	I - 4.83x10 ⁹ J - 3.77x10 ¹⁰	X - 122.02 Y - 340.85

PRECAST PRESTRESSED CONCRETE PANELS - SAFE LOAD TABLES

SPAN	SAFE LOAD	MAX. SAFE SHEAR
2.50m (8.20ft)	12549.01kg/m ² (2570.04lbs/ft ²)	18.82Ton. per Panel
2.75m (9.02ft)	11351.12kg/m ² (2324.71lbs/ft ²)	18.73Ton. per Panel
3.00m (9.84ft)	10352.88kg/m ² (2120.27lbs/ft ²)	18.64Ton. per Panel
3.25m (10.66ft)	9508.21kg/m ² (1947.28lbs/ft ²)	18.54Ton. per Panel
3.50m (11.48ft)	8784.21kg/m ² (1799.01lbs/ft ²)	18.45Ton. per Panel
3.75m (12.30ft)	8156.74kg/m ² (1670.50lbs/ft ²)	18.35Ton. per Panel
4.00m (13.12ft)	7607.71kg/m ² (1558.06lbs/ft ²)	18.26Ton. per Panel
4.25m (13.94ft)	7123.27kg/m ² (1458.85lbs/ft ²)	18.16Ton. per Panel
4.50m (14.76ft)	6692.65kg/m ² (1370.66lbs/ft ²)	18.07Ton. per Panel
4.75m (15.58ft)	6307.37kg/m ² (1291.75lbs/ft ²)	17.98Ton. per Panel
5.00m (16.40ft)	5960.61kg/m ² (1220.73lbs/ft ²)	17.88Ton. per Panel
5.25m (17.23ft)	5646.87kg/m ² (1156.48lbs/ft ²)	17.79Ton. per Panel
5.50m (18.05ft)	5361.66kg/m ² (1098.07lbs/ft ²)	17.69Ton. per Panel
5.75m (18.87ft)	5101.25kg/m ² (1044.74lbs/ft ²)	17.60Ton. per Panel
6.00m (19.69ft)	4862.54kg/m ² (995.85lbs/ft ²)	17.51Ton. per Panel
6.25m (20.51ft)	4557.82kg/m ² (933.44lbs/ft ²)	17.41Ton. per Panel
6.50m (21.33ft)	4166.60kg/m ² (853.32lbs/ft ²)	17.32Ton. per Panel
6.75m (22.15ft)	3818.04kg/m ² (781.93lbs/ft ²)	17.22Ton. per Panel
7.00m (22.97ft)	3506.15kg/m ² (718.06lbs/ft ²)	17.13Ton. per Panel
7.25m (23.79ft)	3225.96kg/m ² (660.68lbs/ft ²)	17.03Ton. per Panel
7.50m (24.61ft)	2973.33kg/m ² (608.94lbs/ft ²)	16.94Ton. per Panel
7.75m (25.43ft)	2744.74kg/m ² (562.12lbs/ft ²)	16.85Ton. per Panel
8.00m (26.25ft)	2537.25kg/m ² (519.63lbs/ft ²)	16.75Ton. per Panel
8.25m (27.07ft)	2348.34kg/m ² (480.94lbs/ft ²)	16.66Ton. per Panel
8.50m (27.89ft)	2175.85kg/m ² (445.61lbs/ft ²)	16.56Ton. per Panel
8.75m (28.71ft)	2017.93kg/m ² (413.27lbs/ft ²)	16.47Ton. per Panel

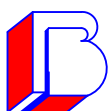

BALLUT BLOCKS SERVICES LTD.

Tel: 21572666, 21573093, 21487738
Fax: 21575562
Email: ballut@maltanet.net

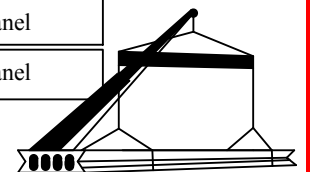

38P24/8

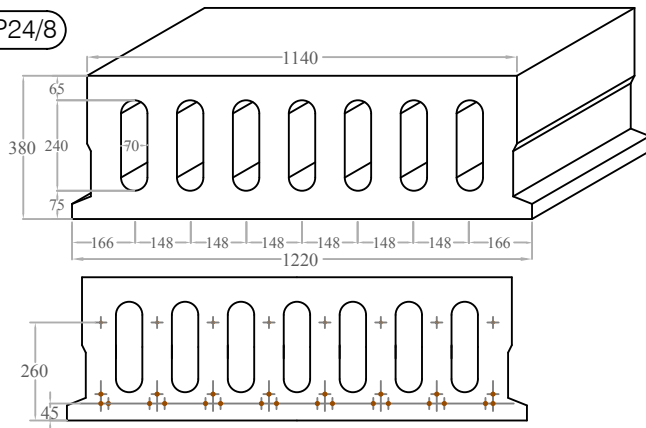

PRODUCTION DIMENSIONS

width - 1220mm
height - 380mm

Date Issued:
September 2005

OWN WEIGHT

Own weight per linear metre 753.36 kg/ l.m

Thickness of Panel - mm	Area mm ²	Centroid mm	Moments of Inertia mm ⁴	Radii of Gyration mm
380	324161	X - 610 Y - 187	I - 4.83x10 ⁹ J - 3.77x10 ¹⁰	X - 122.02 Y - 340.85

PRECAST PRESTRESSED CONCRETE PANELS - SAFE LOAD TABLES

SPAN	SAFE LOAD	MAX. SAFE SHEAR
9.00m (29.53ft)	1872.98kg/m ² (383.59lbs/ft ²)	16.38Ton. per Panel
9.25m (30.35ft)	1739.63kg/m ² (356.28lbs/ft ²)	16.28Ton. per Panel
9.50m (31.17ft)	1616.67kg/m ² (331.09lbs/ft ²)	16.19Ton. per Panel
9.75m (31.99ft)	1503.05kg/m ² (307.82lbs/ft ²)	16.09Ton. per Panel
10.00m (32.81ft)	1397.84kg/m ² (286.28lbs/ft ²)	16.00Ton. per Panel
10.25m (33.63ft)	1300.23kg/m ² (266.29lbs/ft ²)	15.90Ton. per Panel
10.50m (34.45ft)	1209.51kg/m ² (247.71lbs/ft ²)	15.81Ton. per Panel
10.75m (35.27ft)	1125.05kg/m ² (230.41lbs/ft ²)	15.72Ton. per Panel
11.00m (36.09ft)	1046.28kg/m ² (214.28lbs/ft ²)	15.62Ton. per Panel
11.25m (36.91ft)	972.70kg/m ² (199.21lbs/ft ²)	15.53Ton. per Panel
11.50m (37.73ft)	903.87kg/m ² (185.11lbs/ft ²)	15.43Ton. per Panel
11.75m (38.55ft)	839.39kg/m ² (171.91lbs/ft ²)	15.34Ton. per Panel
12.00m (39.37ft)	778.89kg/m ² (159.52lbs/ft ²)	15.25Ton. per Panel
12.25m (40.19ft)	722.06kg/m ² (147.88lbs/ft ²)	15.15Ton. per Panel
12.50m (41.01ft)	668.61kg/m ² (136.93lbs/ft ²)	15.06Ton. per Panel
12.75m (41.83ft)	618.27kg/m ² (126.62lbs/ft ²)	14.96Ton. per Panel
13.00m (42.65ft)	570.80kg/m ² (116.90lbs/ft ²)	14.87Ton. per Panel
13.25m (43.47ft)	526.00kg/m ² (107.72lbs/ft ²)	14.77Ton. per Panel
13.50m (44.29ft)	483.66kg/m ² (99.05lbs/ft ²)	14.68Ton. per Panel
13.75m (45.11ft)	443.61kg/m ² (90.85lbs/ft ²)	14.59Ton. per Panel
14.00m (45.93ft)	405.69kg/m ² (83.09lbs/ft ²)	14.49Ton. per Panel
14.25m (46.75ft)	369.75kg/m ² (75.72lbs/ft ²)	14.40Ton. per Panel
14.50m (47.57ft)	335.64kg/m ² (68.74lbs/ft ²)	14.30Ton. per Panel
14.75m (48.39ft)	303.26kg/m ² (62.11lbs/ft ²)	14.21Ton. per Panel
15.00m (49.22ft)	272.48kg/m ² (55.80lbs/ft ²)	14.12Ton. per Panel
15.25m (50.04ft)	243.21kg/m ² (49.81lbs/ft ²)	14.02Ton. per Panel

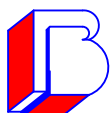

BALLUT BLOCKS SERVICES LTD.

Tel: 21572666, 21573093, 21487738
Fax: 21575562
Email: ballut@maltanet.net

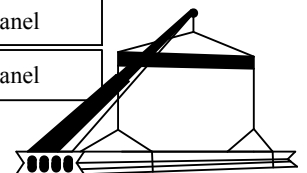

46P28/8

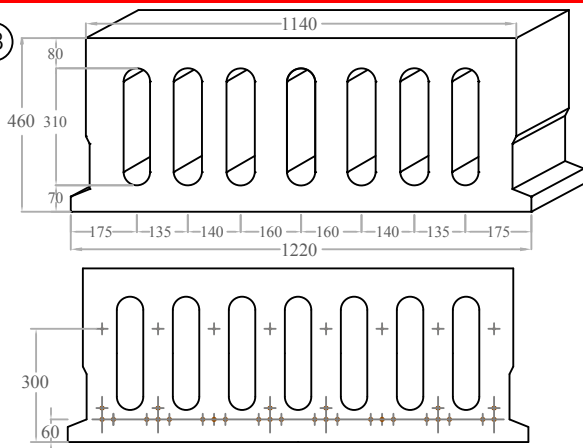

PRODUCTION DIMENSIONS

width - 1220mm
height - 460mm

Date Issued:
September 2005

OWN WEIGHT

Own weight per linear metre 867.74 kg/ l.m

Thickness of Panel - mm	Area mm ²	Centroid mm	Moments of Inertia mm ⁴	Radii of Gyration mm
460	373993	X - 610 Y - 231	I - 8.27x10 ⁹ J - 4.43x10 ¹⁰	X - 148.68 Y - 344.17

PRECAST PRESTRESSED CONCRETE PANELS - SAFE LOAD TABLES

SPAN	SAFE LOAD	MAX. SAFE SHEAR
2.50m (8.20ft)	15167.58kg/m ² (3106.32lbs/ft ²)	22.75Ton. per Panel
2.75m (9.02ft)	13722.97kg/m ² (2810.46lbs/ft ²)	22.64Ton. per Panel
3.00m (9.84ft)	12519.13kg/m ² (2563.92lbs/ft ²)	22.53Ton. per Panel
3.25m (10.66ft)	11500.49kg/m ² (2355.30lbs/ft ²)	22.43Ton. per Panel
3.50m (11.48ft)	10627.38kg/m ² (2176.49lbs/ft ²)	22.32Ton. per Panel
3.75m (12.30ft)	9870.68kg/m ² (2021.51lbs/ft ²)	22.21Ton. per Panel
4.00m (13.12ft)	9208.56kg/m ² (1885.91lbs/ft ²)	22.10Ton. per Panel
4.25m (13.94ft)	8624.35kg/m ² (1766.27lbs/ft ²)	21.99Ton. per Panel
4.50m (14.76ft)	8105.04kg/m ² (1659.91lbs/ft ²)	21.88Ton. per Panel
4.75m (15.58ft)	7640.40kg/m ² (1564.75lbs/ft ²)	21.78Ton. per Panel
5.00m (16.40ft)	7222.23kg/m ² (1479.11lbs/ft ²)	21.67Ton. per Panel
5.25m (17.23ft)	6843.88kg/m ² (1401.63lbs/ft ²)	21.56Ton. per Panel
5.50m (18.05ft)	6499.92kg/m ² (1331.18lbs/ft ²)	21.45Ton. per Panel
5.75m (18.87ft)	6185.88kg/m ² (1266.87lbs/ft ²)	21.34Ton. per Panel
6.00m (19.69ft)	5898.00kg/m ² (1207.91lbs/ft ²)	21.23Ton. per Panel
6.25m (20.51ft)	5633.16kg/m ² (1153.67lbs/ft ²)	21.12Ton. per Panel
6.50m (21.33ft)	5388.69kg/m ² (1103.60lbs/ft ²)	21.02Ton. per Panel
6.75m (22.15ft)	5162.32kg/m ² (1057.24lbs/ft ²)	20.91Ton. per Panel
7.00m (22.97ft)	4855.69kg/m ² (994.44lbs/ft ²)	20.80Ton. per Panel
7.25m (23.79ft)	4477.57kg/m ² (917.01lbs/ft ²)	20.69Ton. per Panel
7.50m (24.61ft)	4136.64kg/m ² (847.18lbs/ft ²)	20.58Ton. per Panel
7.75m (25.43ft)	3828.16kg/m ² (784.01lbs/ft ²)	20.47Ton. per Panel
8.00m (26.25ft)	3548.15kg/m ² (726.66lbs/ft ²)	20.37Ton. per Panel
8.25m (27.07ft)	3293.21kg/m ² (674.45lbs/ft ²)	20.26Ton. per Panel
8.50m (27.89ft)	3060.43kg/m ² (626.78lbs/ft ²)	20.15Ton. per Panel
8.75m (28.71ft)	2847.32kg/m ² (583.13lbs/ft ²)	20.04Ton. per Panel
9.00m (29.53ft)	2651.71kg/m ² (543.07lbs/ft ²)	19.93Ton. per Panel
9.25m (30.35ft)	2471.75kg/m ² (506.22lbs/ft ²)	19.82Ton. per Panel
9.50m (31.17ft)	2305.82kg/m ² (472.23lbs/ft ²)	19.71Ton. per Panel
9.75m (31.99ft)	2152.48kg/m ² (440.83lbs/ft ²)	19.61Ton. per Panel

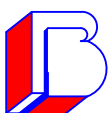

BALLUT BLOCKS SERVICES LTD.

Tel: 21572666, 21573093, 21487738
Fax: 21575562
Email: ballut@maltanet.net

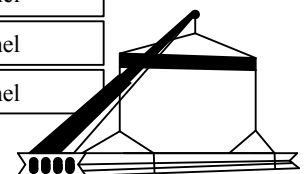

46P28/8

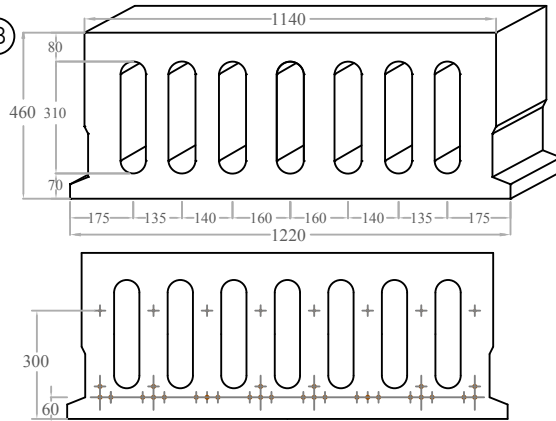

PRODUCTION DIMENSIONS

width - 1220mm
height - 460mm

Date Issued:
September 2005

OWN WEIGHT

Own weight per linear metre 867.74 kg/ l.m

Thickness of Panel - mm	Area mm ²	Centroid mm	Moments of Inertia mm ⁴	Radii of Gyration mm
460	373993	X - 610 Y - 231	I - 8.27x10 ⁹ J - 4.43x10 ¹⁰	X - 148.68 Y - 344.17

PRECAST PRESTRESSED CONCRETE PANELS - SAFE LOAD TABLES

SPAN	SAFE LOAD	MAX. SAFE SHEAR
10.00m (32.81ft)	2010.49kg/m ² (411.75lbs/ft ²)	19.50Ton. per Panel
10.25m (33.63ft)	1878.77kg/m ² (384.77lbs/ft ²)	19.39Ton. per Panel
10.50m (34.45ft)	1756.35kg/m ² (359.70lbs/ft ²)	19.28Ton. per Panel
10.75m (35.27ft)	1642.37kg/m ² (336.36lbs/ft ²)	19.17Ton. per Panel
11.00m (36.09ft)	1536.07kg/m ² (314.59lbs/ft ²)	19.06Ton. per Panel
11.25m (36.91ft)	1436.77kg/m ² (294.25lbs/ft ²)	18.95Ton. per Panel
11.50m (37.73ft)	1343.89kg/m ² (275.23lbs/ft ²)	18.85Ton. per Panel
11.75m (38.55ft)	1256.86kg/m ² (257.41lbs/ft ²)	18.74Ton. per Panel
12.00m (39.37ft)	1175.22kg/m ² (240.69lbs/ft ²)	18.63Ton. per Panel
12.25m (40.19ft)	1098.53kg/m ² (224.98lbs/ft ²)	18.52Ton. per Panel
12.50m (41.01ft)	1026.39kg/m ² (210.21lbs/ft ²)	18.41Ton. per Panel
12.75m (41.83ft)	958.46kg/m ² (196.29lbs/ft ²)	18.30Ton. per Panel
13.00m (42.65ft)	894.40kg/m ² (183.17lbs/ft ²)	18.20Ton. per Panel
13.25m (43.47ft)	833.94kg/m ² (170.79lbs/ft ²)	18.09Ton. per Panel
13.50m (44.29ft)	776.81kg/m ² (159.09lbs/ft ²)	17.98Ton. per Panel
13.75m (45.11ft)	722.76kg/m ² (148.02lbs/ft ²)	17.87Ton. per Panel
14.00m (45.93ft)	671.58kg/m ² (137.54lbs/ft ²)	17.76Ton. per Panel
14.25m (46.75ft)	623.07kg/m ² (127.61lbs/ft ²)	17.65Ton. per Panel
14.50m (47.57ft)	577.05kg/m ² (118.18lbs/ft ²)	17.54Ton. per Panel
14.75m (48.39ft)	533.35kg/m ² (109.23lbs/ft ²)	17.44Ton. per Panel
15.00m (49.22ft)	491.82kg/m ² (100.72lbs/ft ²)	17.33Ton. per Panel
15.25m (50.04ft)	476.78kg/m ² (97.64lbs/ft ²)	17.22Ton. per Panel
15.50m (50.86ft)	438.39kg/m ² (89.78lbs/ft ²)	17.11Ton. per Panel
15.75m (51.68ft)	401.81kg/m ² (82.29lbs/ft ²)	17.00Ton. per Panel
16.00m (52.50ft)	366.93kg/m ² (75.15lbs/ft ²)	16.89Ton. per Panel
16.25m (53.32ft)	333.65kg/m ² (68.33lbs/ft ²)	16.79Ton. per Panel
16.50m (54.14ft)	301.86kg/m ² (61.82lbs/ft ²)	16.68Ton. per Panel
16.75m (54.96ft)	271.50kg/m ² (55.60lbs/ft ²)	16.57Ton. per Panel
17.00m (55.78ft)	242.46kg/m ² (49.66lbs/ft ²)	16.46Ton. per Panel
17.25m (56.60ft)	214.67kg/m ² (43.97lbs/ft ²)	16.35Ton. per Panel



BALLUT BLOCKS SERVICES LTD.

Tel: 21572666, 21573093, 21487738
Fax: 21575562
Email: ballut@maltanet.net

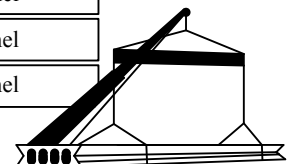

76P36/4/SH 10/150

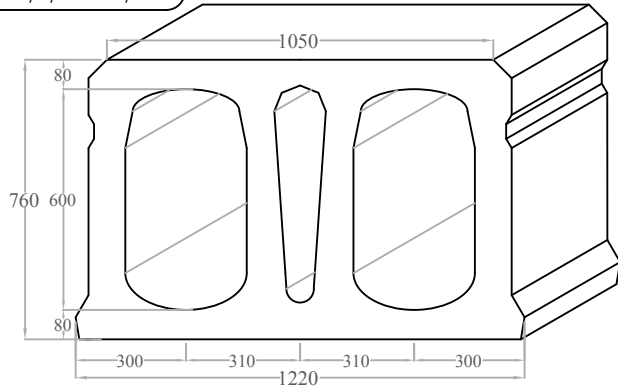

PRODUCTION DIMENSIONS

width - 1220mm
height - 760mm

Date Issued:
September 2005

OWN WEIGHT

Own weight per linear metre 1000kg/1.m

Thickness of Panel - mm	Area mm ²	Centroid mm	Moments of Inertia mm ⁴	Radii of Gyration mm
760	448801	X - 610 Y - 368	I - 3.09x10 ¹⁰ J - 5.87x10 ¹⁰	X - 262.55 Y - 361.54

PRECAST PRESTRESSED CONCRETE PANELS - SAFE LOAD TABLES

SPAN	SAFE LOAD	MAX. SAFE SHEAR
6.00m (19.69ft)	6697.70kg/m ² (1351.21lbs/ft ²)	23.75Ton. per Panel
7.00m (22.97ft)	5544.95kg/m ² (1135.61lbs/ft ²)	23.29Ton. per Panel
8.00m (26.25ft)	4755.38kg/m ² (973.90lbs/ft ²)	22.83Ton. per Panel
9.00m (29.58ft)	4141.27kg/m ² (848.13lbs/ft ²)	22.36Ton. per Panel
10.00m (32.81ft)	3649.99kg/m ² (747.52lbs/ft ²)	21.90Ton. per Panel
11.00m (36.09ft)	3248.02kg/m ² (665.20lbs/ft ²)	21.44Ton. per Panel
12.00m (39.37ft)	2913.06kg/m ² (596.59lbs/ft ²)	20.97Ton. per Panel
13.00m (42.65ft)	2630.00kg/m ² (543.00lbs/ft ²)	20.51Ton. per Panel
14.00m (45.93ft)	2386.60kg/m ² (488.79lbs/ft ²)	20.05Ton. per Panel
15.00m (49.22ft)	2176.13kg/m ² (445.67lbs/ft ²)	19.59Ton. per Panel
16.00m (52.50ft)	1991.90kg/m ² (407.94lbs/ft ²)	19.12Ton. per Panel
17.00m (55.78ft)	1829.34kg/m ² (374.65lbs/ft ²)	18.66Ton. per Panel
18.00m (59.06ft)	1684.84kg/m ² (345.06lbs/ft ²)	18.20Ton. per Panel
19.00m (62.34ft)	1585.56kg/m ² (318.58lbs/ft ²)	17.73Ton. per Panel
20.00m (65.62ft)	1439.20kg/m ² (294.75lbs/ft ²)	17.27Ton. per Panel
21.00m (68.90ft)	1338.92kg/m ² (273.19lbs/ft ²)	16.81Ton. per Panel
22.00m (72.18ft)	1238.22kg/m ² (253.59lbs/ft ²)	16.34Ton. per Panel
23.00m (75.46ft)	1150.84kg/m ² (235.69lbs/ft ²)	15.88Ton. per Panel
24.00m (78.74ft)	1070.73kg/m ² (219.29lbs/ft ²)	15.42Ton. per Panel
25.00m (82.02ft)	997.04kg/m ² (204.19lbs/ft ²)	14.96Ton. per Panel
26.00m (85.31ft)	929.02kg/m ² (190.26lbs/ft ²)	14.49Ton. per Panel
27.00m (88.59ft)	866.03kg/m ² (177.36lbs/ft ²)	14.03Ton. per Panel
28.00m (91.87ft)	807.55kg/m ² (165.39lbs/ft ²)	13.57Ton. per Panel



BALLUT BLOCKS SERVICES LTD.

Tel: 21572666, 21573093, 21487738
Fax: 21575562
Email: ballut@maltanet.net

